

BREEDING IN A SNAIL SHELL: ECOLOGY AND
BIOLOGY OF THE JAMAICAN MONTANE CRAB
SESARMA JARVISI (DECAPODA: GRAPSIDAE)

Rudolf Diesel and Diethard Horst

A B S T R A C T

Sesarma jarvisi is endemic to central western Jamaican limestone hills and mountains, where it inhabits a rock-crevice system in wet limestone forest regions with at least 2,000 mm annual precipitation. The crevice system is characterized by lower and less variable average temperature and higher and less variable humidity than is the forest floor. It also serves as a retreat for other invertebrates, in particular land snails of the genus *Pleurodonte*. Shells of several species of this genus are abundant in the rock rubble. *Sesarma jarvisi* breeds in these shells. Females carrying 3-24 large (1.3 mm) eggs collect water with a field of plumose setae at the rim of the carapace and fill the shells with up to 5 ml of water, into which they release the larvae. Juveniles develop inside the shell until they reach about 8-mm carapace width (CW), when they start to disperse from the brood shell. The mother crab is always present in shells with young up to 3-mm CW and sometimes remains with young up to 6.5-mm CW. Maternal care usually lasts for 2-3 months. A growth curve, using log percentage molt increment and log intermolt period indicates that male sexual maturity occurs at an age of 15-16 months, with an average of 9.7-mm CW. After *Metopaulias depressus*, *S. jarvisi* is the second decapod species for which brood care for larvae and young is reported.

Brachyuran crabs are typically benthic marine organisms with planktonic larvae. In ocypodid, gecarcinid, and many grapsid crabs, adults are well adapted to a terrestrial existence and live up to several kilometers from the coast, but must return to the sea to release their larvae into the marine plankton (Bliss, 1968; Hicks, 1985; Burggren and McMahon, 1988).

A few brachyuran taxa, however, can reproduce independently of the sea; examples are the ocypodid *Uca subcylindrica* (see Rabalais and Cameron, 1985), the superfamily Potamoidea, and some grapsids (*Geosesarma* and some *Sesarma*) (see Hartnoll, 1988). Like many fresh-water or terrestrial taxa that have colonized land from the marine environment (fish; Wotton, 1979; decapods; Rabalais and Gore, 1985), they produce large, yolk-rich eggs, and their larval development is either abbreviated and lecithotrophic or completely reduced, with miniature adults hatching directly from the eggs (Rabalais and Gore, 1985).

Crabs that reproduce on land by means of larval stages still require at least a small amount of water for their development. Examples are *Armases* (= *Sesarma*) *miersii* (Rathbun) (see Abele, 1992), breeding in ephemeral, supratidal rock pools (Schuh and Diesel, in press), and *Metopaulias depressus*

Rathbun, breeding in bromeliads (Diesel, 1989). In fresh water, however, planktonic larval stages are exposed to rather harsh and unpredictable conditions compared to the sea. Fluctuating ion availability, nutritional resources, and predation pressure in fresh water require particular adaptations in the early life history of these species (Greenaway, 1988; Little, 1990).

On the Caribbean island of Jamaica, grapsid crabs of the genera *Sesarma* and *Metopaulias*, most described between 1892 and 1914 (Benedict, 1892; Rathbun, 1896, 1914), have evolved into true terrestrial species; that is, they show adaptations permitting an extended activity out of permanent water (Burggren and McMahon, 1988, p. 3, for definition of "land crabs"), and they breed in terrestrial habitats. Today, six endemic species (*Sesarma bidentatum* Benedict, *S. windsor* Türkay and Diesel, *S. cookei* Hartnoll, *S. jarvisi* Rathbun, *S. verleyi* Rathbun, and *Metopaulias depressus*) populate the banks of streams and rivers, mountain forests, limestone caves, and bromeliads (Hartnoll, 1964a, b, 1965, 1971; Abele and Means, 1977; Türkay and Diesel, in press). Hartnoll (1971) suggested that these species are the result of an adaptive radiation from an ancestor similar to *Sesarma curacaoense* de Man, which in-

habitats mangrove swamps in the Caribbean. Little is known of the ecology and reproductive pattern for most of these species, except for the bromeliad crab *M. depressus*. This species produces large eggs (freshly spawned eggs 1.2 mm in diameter) and has an abbreviated lecithotrophic larval development, consisting of only two zoeal stages and one megalopa (Hartnoll, 1964a; Diesel and Schuh, 1993). Larval and juvenile development takes place in the leaf axils of bromeliads (Diesel, 1989). The abiotic and biotic conditions in bromeliad axils have been selected for a distinct maternal brood-care behavior (Diesel, 1989, 1992a, b; Diesel and Schuh, 1993).

The only other Jamaican endemic species on whose ecology some information is available is the mountain crab *S. jarvisi*. Abele and Means (1977) studied this species in central Jamaican limestone forests and found adults and juveniles on the forest floor among limestone talus and rock-rubble substrates. They collected ovigerous females with few, large eggs from which large larvae hatched but died shortly afterward. The only water in the limestone hills that seemed likely to serve as larval habitat was that in bromeliads, but no larvae, juveniles, or adults were found in the leaf axils.

Abele and Means (1977) suggested several possible reproductive scenarios for *S. jarvisi*: (1) larvae hatch and are held by the female, (2) larvae develop in wet spots among the rubble after heavy rains, (3) larvae are released into ephemeral streams, (4) larvae develop in bromeliads, and (5) larvae are washed into the ground water and develop in the extensive limestone karst.

Until 1991, however, the ecology and particularly the breeding behavior of *S. jarvisi* remained unknown. Here, we provide information on the distribution and the habitat of the species, characterize the microclimate in its microhabitat, and give details on aspects of the biology of the species, in particular its growth pattern, breeding habitat, and behavior.

MATERIALS AND METHODS

Habitat.—The field investigations were carried out in central western Jamaica from March to August 1991 and March to July 1992. Laboratory studies were carried out at the Discovery Bay Marine Laboratory (DBML, Jamaica) and at the University of Bielefeld (UB, Germany).

The main study area was the limestone karst hills of the Cockpit Country in the vicinity of Windsor (Trelawny, Sherwood Content District, altitude 100–200 m above sea level). Additional studies were carried out at Mount Diablo (St. Ann/St. Catherine, altitude 500–800 m), on Heron's Hill (Mile Gully Mountains, Manchester, altitude 800 m), and at Dolphin Head (Hanover, altitude 400 m). These areas are covered by wet limestone forest and characterized by an annual precipitation of 2,000 mm or more (Asprey and Robbins, 1953). Precipitation in Windsor (Fig. 1) shows two annual peaks, one in May and one in September/October. Rainfall is lowest from January to March. Almost no rain fell during these months in 1992. Additional searches for *S. jarvisi* were carried out in various parts of the island.

The abundance of *S. jarvisi* in Windsor was studied in several locations, including the tops of karst hills, their steep slopes, and the valleys in between (cockpits), which were usually covered with a thick bauxite topsoil and extensively used as plantations.

Snail Shells as Breeding Habitat.—The limestone regions of Jamaica support a large variety and high density of land snails. In particular, the large snails of the genus *Pleurodonte* are very abundant (Goodfriend, 1986a).

The crevice system of the rock-rubble layer extends from 10–100 cm of thickness above solid limestone rock, and is usually covered by a thin layer of leaf litter and partially filled with eroded bauxite soil and humus, containing the roots of shrubs and trees. Removal of the rock rubble revealed large accumulations of snail shells. To obtain data on the relative abundance of snail species and shell size, we collected shells from randomly chosen locations by removing the rubble layer from an area of 2–4 m². All shells were collected and transported to the field station, where the species were recorded and their contents studied. The following shell measurements were taken with calipers: SH, shell height; SW, shell width; AW, aperture width; and AH, aperture height (Fig. 2). We measured shell volume for subsamples of all species by filling shells with water and measuring the water volume in a 50-ml measuring flask.

Shell shape, particularly the shell volume and the aperture area, varies widely within species (Goodfriend, 1986b). We hypothesized that two factors should be important to shell choice by female crabs: aperture area, which must be large enough for the crab to enter, and the ratio of aperture size and volume, which should affect evaporation rate and therefore relative humidity within the shell. This hypothesis was tested for the shells of the endemic snail species *Pleurodonte lucerna* (Müller), which were most frequently used by the crabs for breeding.

Because we could not study the contents of snail shells without breaking them, volume of these shells was estimated from their dimensions. Volume was measured for a sample of various-sized shells, and the formula $Vol_{cal} = SW^2 \times \pi/4 \times AH$ was derived for that purpose. Vol_{cal} was significantly correlated with the measured volumes ($r = 0.95$, $P < 0.0001$, $N = 255$, $Vol_{mes} = 3.2125 + 0.5174 \times Vol_{cal}$). An index (V/A) was also calculated for the relationship of calculated volume to aperture area.

Recordings of Microclimate.—To characterize the microclimate in the habitat of *S. jarvisi*, we recorded diel

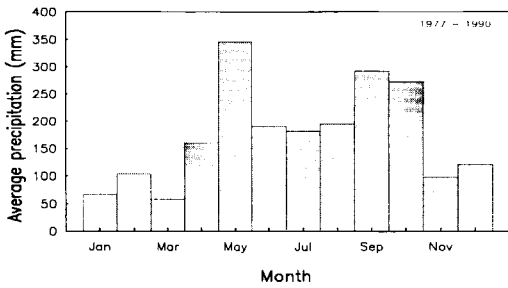

Fig. 1. Monthly precipitation at Windsor, averages from 14 years (data from Meteorological Service, Norman Manley International Airport, Jamaica).

variations in relative humidity and temperature 5 cm above the forest floor and between the rock rubble at 50–70-cm depth. Readings were taken every 5 min for up to 48 h with a Psion LZ 64 Organizer II connected to a TIS-datalogger. The probes used were an AD 590 (Spoerle Electronics; sensitivity $\pm 0.2^\circ\text{C}$) and an Ahlborn type FH 9616–3 R ($\pm 2\%$) for relative humidity.

Food.—To determine food preferences of adults, we kept 10 crabs individually in plastic containers (90 \times 90 mm, 70 mm high) at the DBML, provided with a layer of 10-mm bauxite soil and a small rain-water reservoir. The following food items were put into each container: one millepede segment with muscle tissue and gut content and 10 \times 10-mm pieces of green, wet decomposed, and dry decomposed leaves. The containers were checked at 5-min intervals for the first 2 h and twice daily for the following 5 days.

Molting and Growth.—For the study of molting and growth, juveniles and adults were held in climate chambers at the UB under a light regime (L:D) of 13:11, at 26°C and 75% relative humidity during the day and 21°C and 90% during the night. Juveniles were held individually in 250-ml plastic containers filled with 5 mm limestone soil. One group ($N = 12$) had access to a water reservoir about 6 mm deep; the other group ($N = 12$) was held on moist ground only. The animals were checked every second day and fed 10-mm pieces of earthworms and lettuce. The carapace width (CW) was measured with digital calipers in mm as the widest extension of the posterior carapace. Measurements were taken before and after the molt while the carapace was in hard condition. The intermolt duration was recorded.

Groups of adult crabs, each consisting of 5 males and 5 females were kept under the same climatic and food regime in 3 larger terraria (600 \times 300 \times 250 mm) with 10 empty snail shells each. The size at molt of puberty was inferred from the positive allometric growth of the male chela, measured as the length of the propodus from the finger tip to the articulation of the carpus, and the female maximum abdomen width (see Hartnoll, 1965).

Growth Curve.—A growth curve was calculated from the data obtained during molting in the climate chamber. According to Hartnoll (1983), growth curves can be generated from the regressions of \log_{10} intermolt period on CW (LogIP) and \log_{10} percentage molt increment on CW (LogMI%).

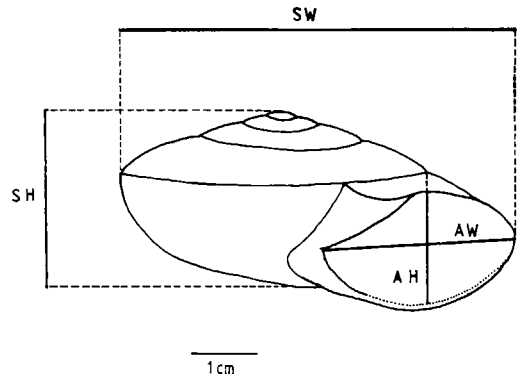

Fig. 2. Shell of *Pleurodonte lucerna*; position of standard measurements. SW = shell width; SH = shell height; AW = aperture width; AH = aperture height.

Water-Carrying Behavior.—Water-carrying behavior was observed for 5 ovigerous females kept in plastic terraria (250 \times 150 \times 150 mm) at UB. Each terrarium held a previously cleaned and dried shell of *Pleurodonte lucerna* in one corner and a Petri dish containing 40 ml water in the other. After 3, 6, and 9 days, the shells were removed and the water content measured in a 10-ml measuring flask. The water was then replaced in each shell and the shell put back into the terrarium. Unfortunately, none of the larvae of the females hatched.

In order to study body structures that might be used for carrying water, we examined a female under the scanning electron microscope (SEM). The crab was dehydrated in ethanol, critical-point dried, and sputter-coated with gold-palladium for 1 min.

RESULTS

General Biology and Ecology

Distribution and Habitat.—*Sesarma jarvisi* lives in the western central mountains of Jamaica. Individuals were found from Mt. Diablo in the east to Mt. Dolphin Head in the west (Fig. 3). Intensive searches in lowland and coastal areas and in the mountainous regions of eastern Jamaica (Blue Mountains and John Crow Mountains) revealed no specimens. All locations inhabited by *S. jarvisi* were within areas of wet limestone forest and high precipitation.

The species inhabits crevices and small cavities under limestone boulders and rock rubble on the forest floor, particularly in shaded and moist areas. Man-made stone walls in abandoned plantations, now overgrown by secondary forest, were also frequently inhabited. In the limestone forests of western Jamaica these underground crevice systems are very common and provide an extensive habitat for *S. jarvisi* and numerous other invertebrates and vertebrates.

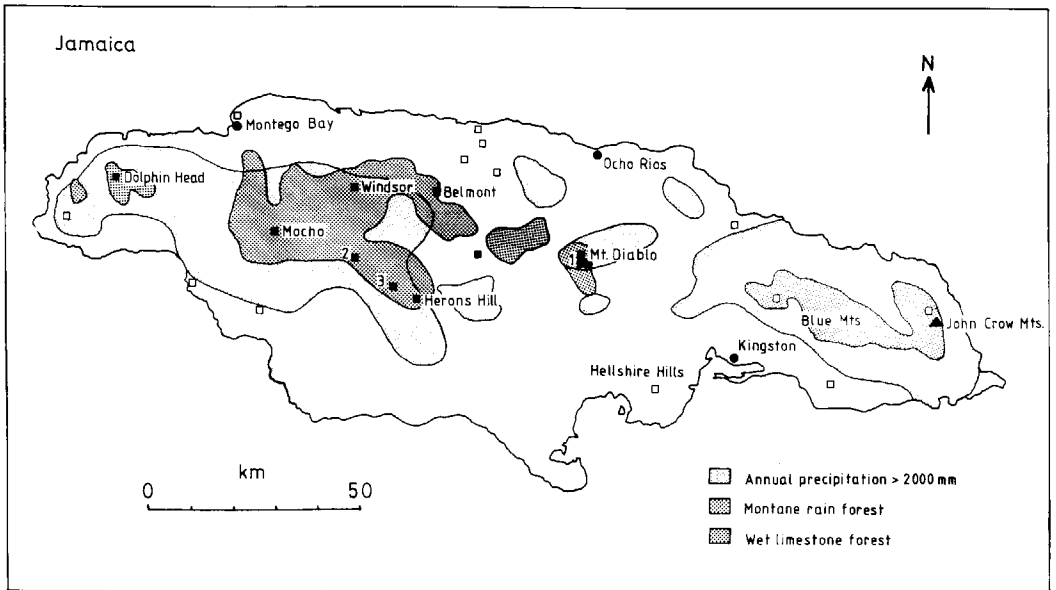

Fig. 3. Distribution of *Sesarma jarvisi* in Jamaica. ■: localities where *S. jarvisi* occurs; numbers indicate records by (1) Rathbun (1914), Abele and Means (1977), (2) Hartnoll (1964a), (3) Abele and Means (1977). □: locations searched for *S. jarvisi* without success. ▲: location where *S. cookei* inhabits a habitat similar to that of *S. jarvisi*.

Searches for *S. jarvisi*, in which boulders and rock rubble were removed from large areas of the forest floor, revealed 122 adult crabs (45 males and 77 females) and some juveniles.

Microclimate of the Limestone-Crevice System.—Temperature and relative humidity in the crevice system and on the forest floor varied with the time of day (Fig. 4), but significantly less so in the crevice system than on the shaded forest floor at Windsor (ANOVA, relative humidity, $F_{576} = 8.95$, $P < 0.01$; temperature, $F_{576} = 3.51$, $P < 0.01$) and at Discovery Bay on the relatively dry north coast (relative humidity, $F_{489} = 1.79$, $P < 0.02$; temperature, $F_{489} = 5.13$, $P < 0.01$). In both areas, mean temperature was lower and relative humidity higher in the crevice system than on the forest floor. At Windsor, mean temperature on the forest floor was 24.0°C and relative humidity 76.8%, and in the crevice system 22.1°C and 89.3%, respectively (t -test, $t_{Temp} = 17.0$, $P < 0.0001$; $t_{RH} = 38.0$, $P < 0.0001$, respectively). At Discovery Bay, mean temperature on the forest floor was 24.8°C and relative humidity 72.8%, and in the crevice system 23.2°C and 91.0%, respectively ($t_{Temp} = 10.9$, $P < 0.001$; $t_{RH} = 48.2$, $P < 0.0001$,

respectively; see Fig. 5). In both locations measurements were taken on sunny days during the onset of the rainy season.

The measurements in Discovery Bay are representative for habitats not inhabited by *S. jarvisi*. A comparison of the variances in relative humidity within the crevice system in Windsor and Discovery Bay shows a significant higher fluctuation in Discovery Bay than in Windsor (ANOVA, $F_{576,489} = 60.0$, $P < 0.001$); this was not the case for temperature ($F_{576,489} = 1.06$, *n.s.*).

At Windsor, the relatively constant temperature and humidity conditions in the crevice system, and the average lower temperature and higher humidity during the day, provide a retreat from desiccation not only for *S. jarvisi*, but also for other invertebrates like the abundant millipedes (*Iulus* spp.) and large land snails (*Pleurodonte* spp.). Living specimens of *Pleurodonte lucerna*, *P. bainbridgi* Pfeiffer, *P. jamaicensis* Gmelin, and *P. aspera* Férussac, and especially their empty shells, were extremely abundant in the crevice system (Fig. 6).

Molting, Growth, and Sexual Maturity

Molting and Growth.—Although Abele and Means (1977) reported that *S. jarvisi* have

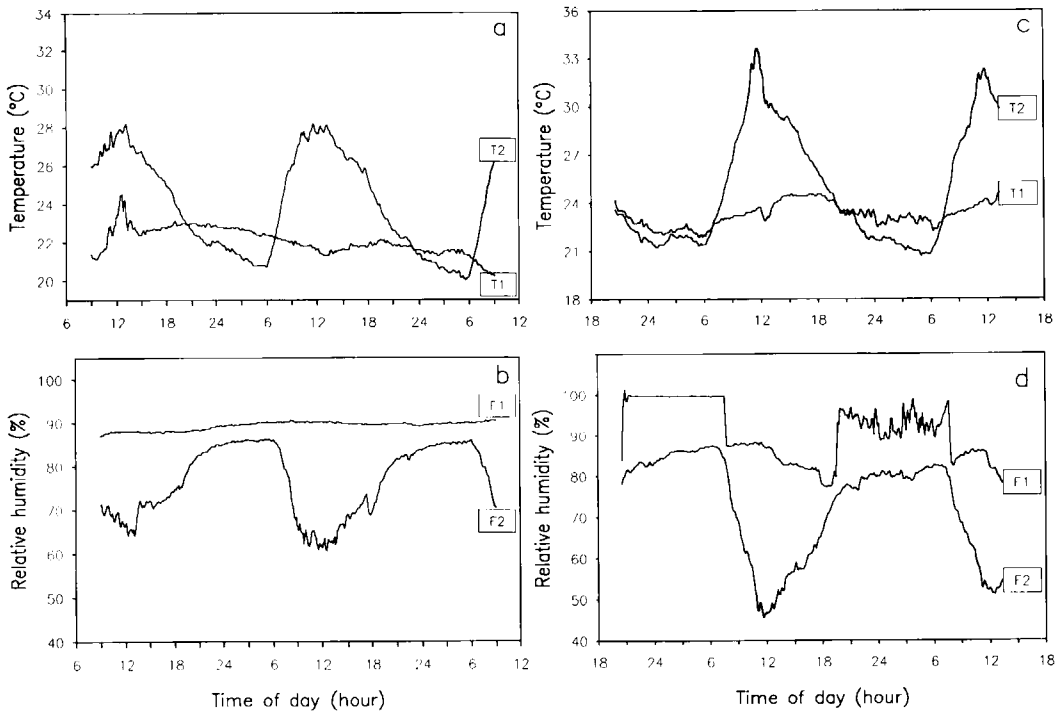

Fig. 4. Variation in temperature and relative humidity in the crevice system and at the forest floor measured in Discovery Bay near the coast (a, b) and at Windsor in central Jamaica (c, d). Temperature (T1) and relative humidity (F1) = measurement from crevice system; T2 and F2 = measurement from forest floor.

large pericardial sacs, which might enable crabs to molt on dry land (Mason, 1970), in the laboratory, *S. jarvisi* molted successfully only if sufficient water to fully submerge the body was available. Juveniles kept in boxes with sufficient water molted an average of five times within eight months ($N = 12$). Individuals in boxes with moist substrate failed to molt during the same period ($N = 12$). These animals stopped feeding after 1–2 months. After 3–7 months ($\bar{x} = 160$ days), they died in proecdysis.

In the field, shells with broods held water, which, as the juveniles grew, became mingled with organic matter and increasingly muddy. In shells with young larger than 5-mm CW little free water remained; the crabs lived in wet mud that filled the interior of the shell up to the first whorl. In this substrate numerous exuviae were found, demonstrating that juveniles are capable of molting in this mud.

Because the limestone substrate is so porous, surface water is very rare in the western central regions of Jamaica; streams and rivers are almost lacking (Day, 1985). The

only permanent water in the area is the rain water stored in the leaf axils of terrestrial and arboreal bromeliad plants (*Aechmea paniculigera* Griseb. and *Hohenbergia* spp.; Diesel, 1989). Ephemeral rain-water pools occurred on the eroded limestone rocks after heavy rains during the spring rainy season, beginning in April. More than 100 exuviae of adult *S. jarvisi* were found in these rock pools, which held water for a few days. Many pools contained up to four cast crab shells (Fig. 7). Such pools are also utilized for molting by the potamonid crab *Madagopotamon humberti* Bott (see Vuillemin, 1970), a terrestrial crab of Madagascar. One *S. jarvisi* molted in a bromeliad tank but was killed by the resident bromeliad crab *Metopaulias depressus*, and only one cast shell was found in a bromeliad leaf axil, even though more than 1,000 bromeliads were studied from 1986 to 1992 (R. Diesel, unpublished).

Molting was observed in crabs ranging in size from 5–11-mm CW. The relative increase was an average of $11.2 \pm 1.8\%$ ($N = 46$ molts of 12 individuals). In crabs larger

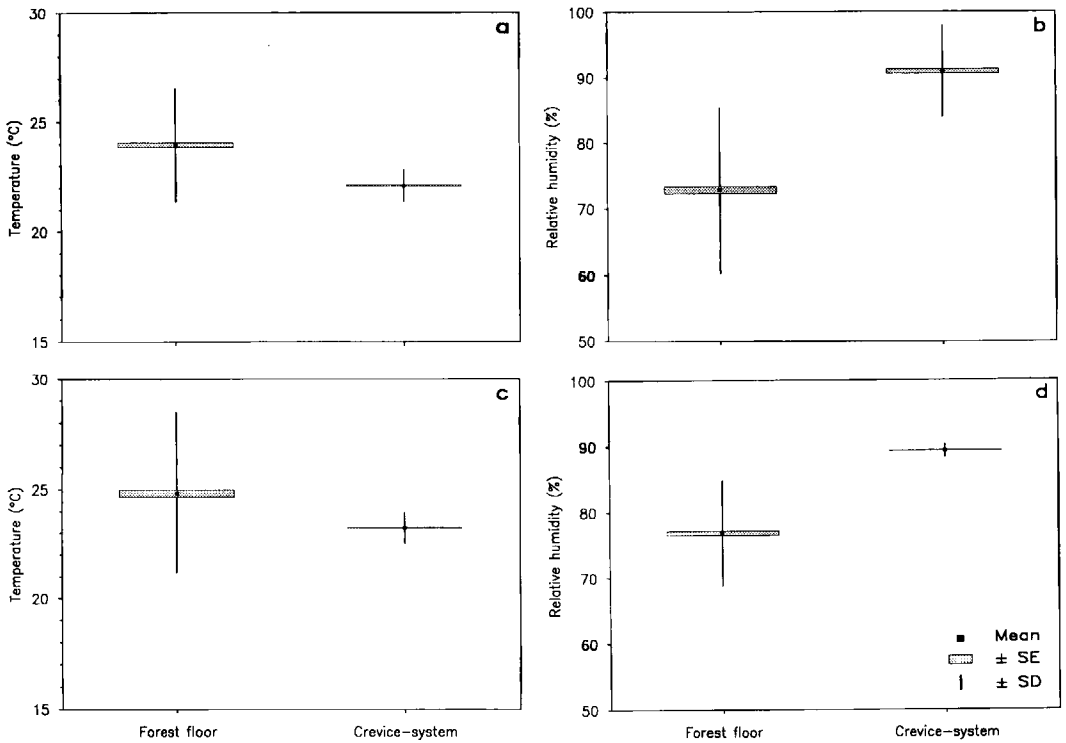

Fig. 5. Mean (\pm SE \pm SD) temperature and relative humidity at the forest floor and within the crevice system (a, b) at Discovery Bay and (c, d) at Windsor.

than 12-mm CW, the relative increase was only $4.6 \pm 0.7\%$ ($N = 6$). There was a significant negative linear correlation between carapace width and log percentage molt increment (Fig. 8), as well as between CW and the log intermolt period (Fig. 9).

According to a growth curve generated as described by Hartnoll (1983), maternal care in *S. jarvisi* lasts for 2–3 months and occasionally for up to eight months, but juveniles may grow slightly faster in the field, since food there may be “better” food than we could provide in the laboratory. Adults may on the other hand grow more slowly than in the laboratory, where water was permanently at hand; in the field, water for molting is available only during the rainy season, when mass molting occurs.

Sexual Maturity.—In males a sharp allometric increase in chela length occurred between 9 and 10 mm-CW (Fig. 10), marking the molt of puberty. In captivity, the CW of the largest juvenile males ranged from 8.7–9.8 mm ($\bar{x} = 9.24 \pm 0.41$ mm; $N = 7$), the CW of the smallest adult males from

9.7–10.8 mm ($\bar{x} = 10.23 \pm 0.45$ mm; $N = 7$). For female *S. jarvisi*, whose pleon is very narrow compared to those of other sesar-mids, data on the puberty molt could not be obtained. Only two females molted to maturity in captivity. The smallest ovigerous female observed in the field had a CW of 10.2 mm.

Growth Curve.—From the data on molt increment per molt and intermolt period, a growth curve was calculated (see Materials and Methods) on the basis of molting events in the laboratory. According to the growth curve, *S. jarvisi* reaches its largest body size of about 15-mm CW after about five years (Fig. 11a). Sexual maturity is reached at an age of about 15–16 months (Fig. 11b).

Breeding Biology

Breeding Habitat: Snail Shells.—Searches for the breeding habitat of *S. jarvisi* between 1986 and 1990 were unsuccessful; neither the water tanks in bromeliads nor the limestone rock pools (more than 100 searched) revealed any larvae or juvenile crabs.



Fig. 6. Accumulation of land-snail shells within the limestone rock rubble. Photo taken at Windsor after a surface layer of stones was removed. Scale bar = 10 mm.

During the search for adult crabs, large accumulations of empty shells of snails of the genus *Pleurodonte* (Stylommatophora, Camaenidae) were found regularly in the crevice system. Small cavities under the rocks sometimes contained more than 50 shells (Fig. 6). During a search in April 1991, shells were collected and opened; some of these contained juvenile *S. jarvisi* (Fig. 12). Subsequently, of more than 1,300 shells studied, 172 held juveniles (were "brood-shells"); they were found in Windsor ($N = 118$), at Mt. Diablo ($N = 26$), on Heron's Hill ($N = 27$), and at Dolphin Head ($N = 1$), and represented *Pleurodonte lucerna*, *P. bainbridgi*, *P. jamaicensis*, and *P. aspera* (Fig. 13). The average size of juveniles in brood-shells ranged from 1.4–8.8-mm CW. At Windsor, three sample areas, each of 2–4 m², revealed 57, 83, and 71 shells of *P. lucerna*, of which 1, 2, and 2 were brood-shells, respectively.

Snail shells were also used by other organisms as retreats or breeding sites; in 300 opened shells, the following animals or their

clutches were found: shells of small land snails, eggs of species of *Pleurodonte*, onychophorans, collembolans, machilids, chilopods, diplopods and their brood chambers, mites, pseudoscorpions, scorpions (2 exuviae), spiders, isopods, hemipteran nymphs, dipteran larvae and pupae, ant nests with eggs, larvae and pupae and eggs of solitary bees, and lizard eggs.

The abundance of the four species of *Pleurodonte* differed with locality (Table 1). At 61–94%, shells of *P. lucerna* were the most abundant. Shells of the other species were much less frequent, except those of *P. jamaicensis* at Heron's Hill.

The species differed considerably in morphological shell pattern, particularly in shell diameter and height and in aperture width, height, and volume (Tables 2, 3). Shell morphology also varied with locality within species; e.g., SH, SW, AH, and AW of *P. lucerna* differed significantly among the four places where *S. jarvisi* was found (ANOVA, $F_{3,1059} = 1333.5$, $P < 0.0001$, and $P < 0.0001$ for all LSD post hoc comparisons). For ex-

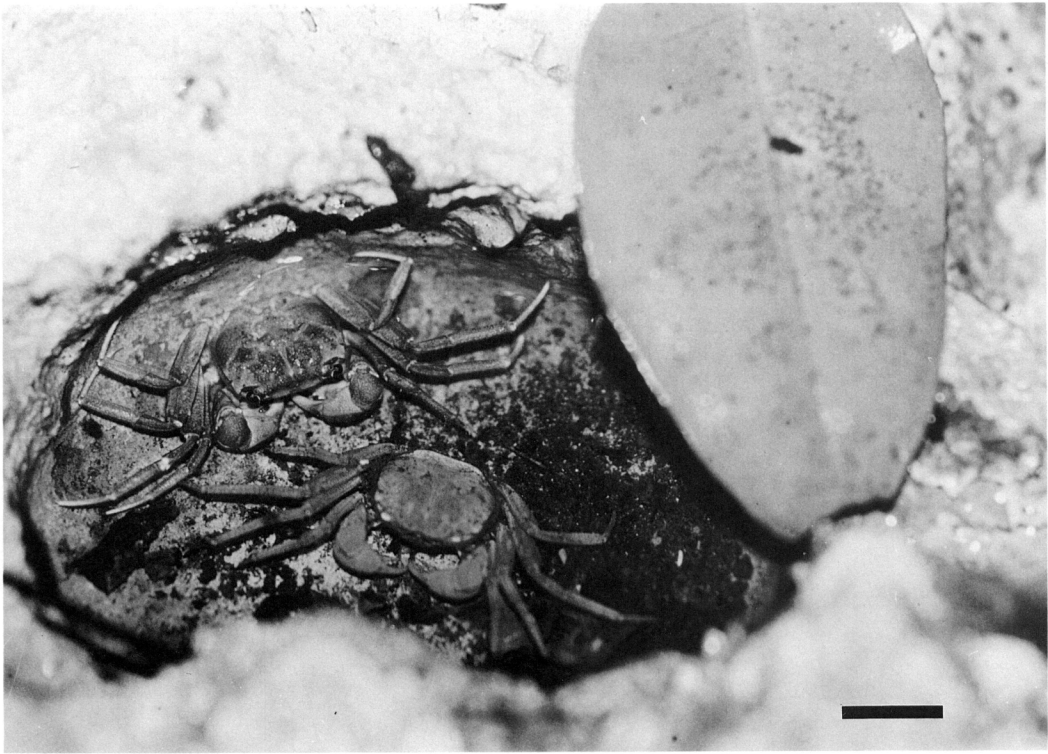

Fig. 7. Large *Sesarma jarvisi* molting in an ephemeral limestone rockpool. Here a freshly molted male is shown next to its exuviae. Scale bar = 10 mm.

ample, *P. lucerna* in Windsor had an average shell diameter of 55.2 mm and an aperture height of 13.0 mm, whereas on Heron's Hill they grew only to an average shell diameter of 40.3 mm and an aperture height of 9.3 mm. This difference is reflected in the shell volume as well; in Windsor *P. lucerna* had an average volume of 19.4 ml,

on Heron's Hill only 9.4 ml, and in the Hellshire Hills only 7.6 ml. The Hellshire Hills receive less than 1,000 mm of annual precipitation (Morrissey, 1983), and *S. jarvisi* was not found there.

In Windsor, shells with broods had a significantly higher V/A index than other shells (*t*-test, $t = 6.15$, $P < 0.001$, $N_{\text{empty shells}} =$

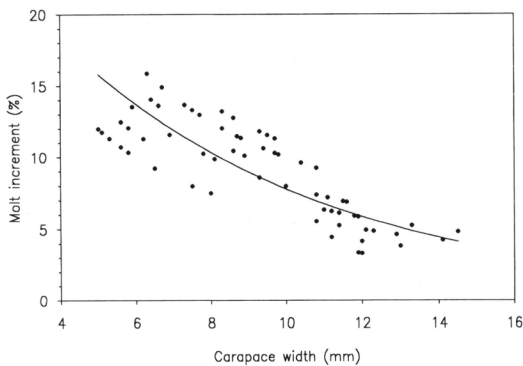

Fig. 8. Relationship between carapace width before molt and percentage molt increment in *Sesarma jarvisi* ($r = 0.84$, $P < 0.0001$, $N = 67$, $\text{Log}_{10}\text{MI}\% = 1.5063 - 0.06154 \times \text{CW}$).

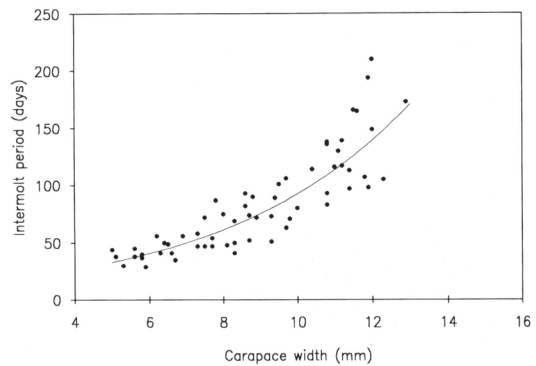

Fig. 9. Relationship between carapace width before molt and intermolt period in *Sesarma jarvisi* ($r = 0.90$, $P < 0.0001$, $N = 61$, $\text{Log}_{10}\text{IP} = 1.07573 - 0.08895 \times \text{CW}$).

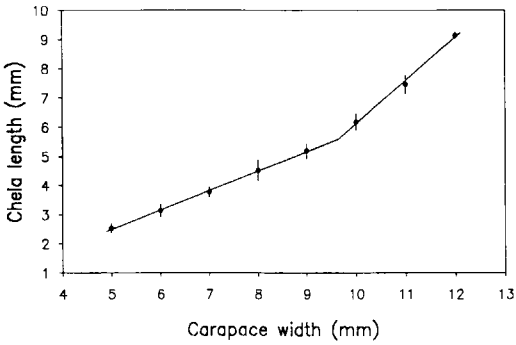

Fig. 10. Relationship between male chela length and carapace width in *Sesarma jarvisi* ($\bar{x} \pm SD$ of 1-mm size classes).

367, $N_{\text{brood-shells}} = 50$). Females of *S. jarvisi* thus utilized shells with a high ratio of volume to aperture area (Fig. 14). The same relationship was found for the shells of the other species, but the differences were not significant, probably because of the smaller sample sizes.

Eggs.—Ovigerous females with 3–24 eggs (median 12 eggs) were observed in the field ($N = 5$) and in the laboratory ($N = 4$). Fresh eggs measured an average of 1.3 mm in diameter and were of a light beige color and almost unpigmented before hatching. Larvae were not observed.

Brood Size and Presence of Mother.—In brood shells collected in the field, the number of juveniles in relatively young broods (CW < 3 mm) ranged from 2–17 individuals; one shell with larger juveniles held 26

Table 1. Relative abundance of shells of species of *Pleurodonte* in Jamaica in different sample areas (A) and total number of broods of *Sesarma jarvisi* found in the shells of each species (B).

Location	<i>P. lucerna</i> %	<i>P. bain-bridgi</i> %	<i>P. jamaicensis</i> %	<i>P. aspera</i> %	<i>N</i>
Windsor					
A	93.9	3.8	2.3	—	346
B	107	7	4	0	
Mt. Diablo					
A	88.2	6.6	5.2	—	289
B	22	3	1	0	
Heron's Hill					
A	61.1	0	31.7	7.2	400
B	14	0	12	1	
Dolphin Head					
A	90.8	0	0	9.2	229
B	0	0	0	1	

(Fig. 15). In 91.9% ($N = 172$) of the shells, more than one juvenile was found. The number of juveniles per shell decreased with increasing body size (Fig. 15).

In 18.6% of the brood shells ($N = 172$), an adult female, presumably the mother, was found with the young, and this was the case in 100% ($N = 17$) of the shells with juveniles smaller than 3-mm CW. In shells with young that were an average of larger than 6.5-mm CW, a female was never present. The smallest juvenile caught outside a snail shell measured 7.2 mm CW.

Maternal Care.—Larvae and juveniles depend on water for development but only

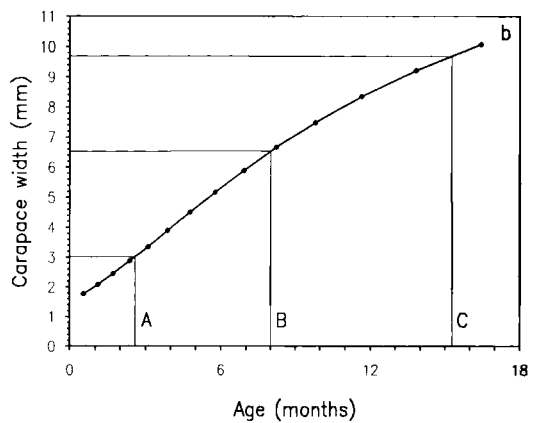
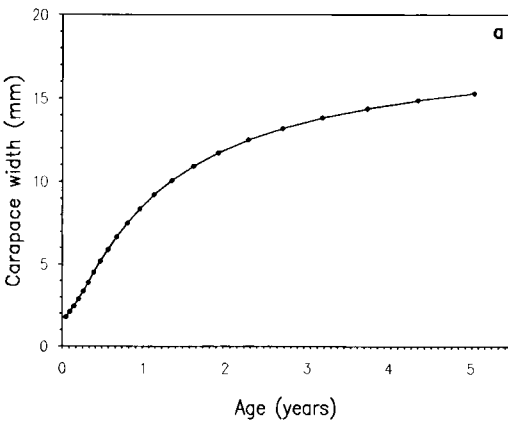

Fig. 11. Calculated growth curve for *Sesarma jarvisi*. (a) Growth curve for several years and (b) enlarged for a shorter period. A: Age of juveniles with mother always present; B: age up to which mother was sometimes present; C: age at molt of puberty.